



## HK1616-2RS

Drawn cup needle roller bearing open end

Schaeffler ID:  
0007000370968

Drawn cup needle roller bearings with open ends HK..-2RS, lip seals on both sides, to DIN 618

### Technical information

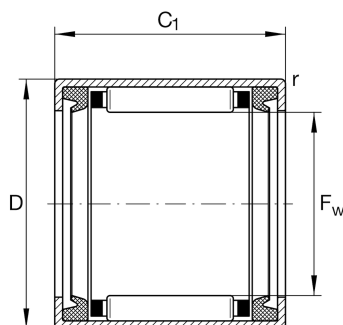

#### Main Dimensions & Performance Data

$F_w$	16 mm	Under roller diameter
$D$	22 mm	Outside diameter
$C$	16 mm	Width
$C_r$	7,600 N	Basic dynamic load rating, radial
$C_{0r}$	9,700 N	Basic static load rating, radial
$C_{ur}$	1,180 N	Fatigue load limit, radial
$n_G$	9,300 1/min	Limiting speed
$n_{G \text{ Grease}}$	9,300 1/min	Limiting speed for grease lubrication
	13.94 g	Weight

#### Dimensions

$C_1$	16 mm	Width, outer ring
$r_{\min}$	0.8 mm	Minimum chamfer dimension
	IR12X16X16-XL	Suitable inner rings IR

#### Temperature range

$T_{\min}$	-20 °C	Operating temperature min.
$T_{\max}$	100 °C	Operating temperature max.